

OPERATING MANUAL

ECO 120-HayTemp Alarm thermometer



B-H86.0.0h.DK2-1.0



Contents

1.1	About this documentation.....	4
1.2	Foreword.....	4
1.3	Legal notices.....	4
1.4	Further information	4
2	Safety	5
2.1	Explanation of safety symbols	5
2.2	Foreseeable misuse.....	5
2.3	Safety instructions.....	6
2.4	Intended use	7
2.5	Qualified personnel.....	7
2.6	Variants.....	7
3	The device at a glance	8
3.1	Display elements	8
3.2	Connections	8
3.3	Operating elements	9
4	Operation	10
4.1	Opening the configuration menu	10
4.2	Adjustment of the measuring input	11
5	Measurement Basics	13
5.1	Sensor/device accuracy	13
5.2	Possible measuring errors	13
5.2.1	Immersion depth.....	13
5.2.2	Surface effects and poor heat transfer	13
5.2.3	Cooling / evaporation	14
5.2.4	Response time	14
6	Operation and maintenance.....	15
6.1	Operating and maintenance notices	15
6.2	Battery	15
6.2.1	Battery indicator	15
6.2.2	Changing battery	15

7	Error and system messages	17
8	Disposal	18
9	Technical data	19
10	Service	21
10.1	Manufacturer	21
10.2	Calibration and adjustment service	21

1.1 About this documentation

1.2 Foreword

Read this document carefully and familiarize yourself with the operation of the device before you use it.

Keep this document ready to hand and in the immediate vicinity of the device so that it is available to the personnel/user for reference at all times in case of doubt.

The user must have carefully read and understood the operating manual before beginning any work.

1.3 Legal notices

The liability and warranty of the manufacturer for damages and consequential damages are voided with misuse, disregarding this document, disregarding safety notices, assignment of inadequately qualified technical personnel and arbitrary modifications of the device.

This document is entrusted to the recipient for personal use only. Any impermissible transfer, duplication, translation into other languages or excerpts from this operating manual are prohibited.

The manufacturer assumes no liability for print errors.

1.4 Further information

Software version of the device: V1.2 or later

For the exact product name, refer to the type plate on the rear side of the device.

Note

For information about the software version, press and hold the ON button to switch on the device for longer than 5 seconds. The series is shown in the main display and the software version of the device is shown in the secondary display.

2 Safety

2.1 Explanation of safety symbols

Danger!

This symbol warns of imminent danger, which can result in death, severe bodily injury, or severe property damage in case of non-observance.

Caution!

This symbol warns of potential dangers or harmful situations, which can cause damage to the device or to the environment in case of non-observance.

Note

This symbol indicates processes, which can have a direct influence on operation or can trigger an unforeseen reaction in case of non-observance.

2.2 Foreseeable misuse

The fault-free function and operational safety of the device can only be guaranteed if applicable safety precautions and the device-specific safety instructions for this document are observed.

If these notices are disregarded, personal injury or death, as well as property damage can occur.

Danger! Incorrect area of application!

In order to prevent erratic behavior of the device, personal injury and property damage, the device must be used exclusively as described under intended use.

- ▶ Do not use in safety. Emergency Stop devices!
- ▶ The device is not suitable for use in explosion-prone areas!
- ▶ The device must not be used for diagnostic or other medical purposes on patients!
- ▶ Not suitable for use with requirements on functional safety, e.g. SIL!

2.3 Safety instructions

Caution! Risk of injury at the temperature sensor!

Devices with insertion probes entail the risk of stab injuries due to the pointed probe design.

- ▶ Handle insertion probes with care!
- ▶ Fit a protective cap on the measuring probe if probe is not in use!

There is a risk of burns when measuring in high (and very low) temperatures.

- ▶ Use gloves if necessary.

Empty batteries and batteries of inferior quality can leak more easily, which can destroy the device.

- ▶ Please also observe the instructions in the chapter "Operation and maintenance".

Caution!

There is an immediate danger to life if live parts come into contact with the temperature sensor!

- ▶ Therefore, do not conduct measurements on or in the direct vicinity of live parts or lines.
- ▶ Never plug the temperature sensor into sockets, etc.

Note

This device does not belong in children's hands!

The sensor handle, connecting cable and device housing are not designed for continuous contact with foods.

Designed for continuous contact with foods in accordance with EC Regulation 1935 / 2004:

- The temperature sensor from the measuring tip to approx. 1 cm before the end of the stainless steel tube.

2.4 Intended use

The device is a water-resistant thermometer for measuring the core temperature in bulk goods - for example, for use in hay protection.

It is designed for precise and fast temperature measurements in the following media:

- Not pressed hay and straw
- Bulk material

2.5 Qualified personnel

For commissioning, operation and maintenance, the relevant personnel must have adequate knowledge of the measuring process and the significance of the measurements. The instructions in this document must be understood, observed and followed.

In order to avoid any risks arising from interpretation of the measurements in the concrete application, the user must have additional expertise. The user is solely liable for damages/danger resulting from misinterpretation due to inadequate expertise.

2.6 Variants

Device	Description
ECO 120	<ul style="list-style-type: none"> • Thermometer for exchangeable Pt1000 probes with BNC connector
Probe HayTemp	Fiberglass probe Ø 10 mm with hardened cutting tip, length 4 or 6 m, BNC -cable, integrated Pt1000 2-wire class B

3 The device at a glance



LCD Display



Front view



Top view ECO 120

3.1 Display elements

	Battery indicator	Evaluation of the battery status
	Unit display	Display of units or type of mode, min/max/hold
	Main display	Measurement of the current temperature or value for min/max/hold
	Auxiliary display	Measurement of the current temperature in min/max/hold mode with unit

3.2 Connections

BNC connection
(ECO 120)

Connection for temperature sensor
(Un/locking with rotating ring on the cable plug)

⚠ Caution! Ensuring water tightness!

The device guarantees protection from spray water, rain or accidental immersion in water. This protection for the plug connector is only guaranteed when plugged in. Moisture or contaminants on the contacts can result in incorrect measurement results.

- ▶ Protect contacts from soiling and moisture!
- ▶ Dry off damp plug connectors as quickly as possible!

3.3 Operating elements



On / Off button

Press briefly Switch on the device
 Activate / deactivate lighting

Long press Switch off the device
 Reject changes in a menu



Up / Down button



Press briefly ▶ Display of the min/max value
 Change value of the selected parameter

Long press ▶ Reset the min/max value of the current measurement

Both simultaneously ▶ Rotate display, overhead display



Function button

Press briefly ▶ Freeze measurement (Hold)
 Call up next parameter



Long press, 2s ▶ Start menu "configuration", **CONF** appears in the display

Operating status ▶ device is in measured value display
 Change value of the selected parameter
 ▶ device is in a menu

4 Operation

4.1 Opening the configuration menu

- 1 Press the Function key for 2 seconds to open the Configuration menu.
- 2 $\text{Lo}nF$ appears in the display. Release the Function key.

Parameter	Values	Meaning
	 	
AL	Alarm	
	oFF	No alarm active
	oN	Alarm via text insertion, acoustic signal and flashing of the background lighting
	bEEP	Alarm via text insertion and acoustic signal
	L tE	Alarm via text insertion and flashing of the background lighting
AL.Lo	Min. alarm limit (only available if AL <> off)	
	-70.0 .. AL.Hi	a min. alert is triggered if the value falls below this value. (at °F: -94.0 .. AL.Hi)
	-200.0 .. AL.Hi	a min. alert is triggered if the value falls below this value. (at °F: -328.0 .. AL.Hi) – (at ECO 120)
AL.Hi	Max. alarm limit (only available if AL <> off)	
	AL.Lo .. 250.0	If the value is exceeded, a max. alarm is triggered. (at °F: AL.Hi .. 482.0)
	AL.Lo .. 450.0	If the value is exceeded, a max. alarm is triggered. (at °F: AL.Hi .. 842.0) – (at ECO 120)
PoFF	Shut-off time	
	oFF	No automatic shut-off
	15, 30, 60, 120, 240	Automatic shut-off after a selected time in minutes, during which no buttons have been pressed



Parameter	Values	Meaning
L, EE	Backlight	
	oFF	Backlight deactivated
	15, 30, 60, 120, 240	Automatic shut-off of the backlight after a select-ed time in seconds, during which no buttons have been pressed
	oN	No automatic shut off of the backlight
U, n, t	Display unit	
	$^{\circ}\text{C}$	Temperature display in $^{\circ}\text{C}$
	$^{\circ}\text{F}$	Temperature display in $^{\circ}\text{F}$
i, n, t	Factory settings	
	nO	Use current configuration
	YES	Reset device to factory settings. After confirming with the function-button, the display shows: $i, n, \text{t done}$

4.2 Adjustment of the measuring input

The temperature input can be adjusted with the zero point correction and the gradient correction. If an adjustment is made, you change the pre-adjusted factory settings.

This is signaled with the display text t.oF or t.SL when switching on.

- 1 Switch the device off.
- 2 Hold the down button and press the On/Off button briefly to switch on the device and open the Adjustment menu.
- 3 The display shows the first parameter. Release the down button.

Parameter	Values	Meaning
	 	
t.oF	Zero point correction	
	0.00	No zero point correction
	-5.00 ... 5.00	Zero point correction in $^{\circ}\text{C}$. (at $^{\circ}\text{F}$ -9.00 .. 9.00)

Parameter	Values	Meaning
t.5L	Gradient correction of the temperature	
	0.00	No gradient correction of the temperature
	-5.00 ... 5.00	Gradient correction in %

Formula used by device:

Temperature = °C: Display = (measured value - t.oF) * (1 + t.5L / 100)

Temperature = °F: Display = (meas. value - 32 °F - t.oF) * (1 + t.5L / 100) + 32 °F

Adjustment example:

Temperature unit= °C, the adjustment is carried out in 2 separate steps at 0 °C (e.g. ice water) and at a reference temperature (e.g. clinical thermometer with water bath 37 °C).

► First set the values of t.oF and t.5L in the adjustment menu to 0

- Zero point:
- Set the temperature probe to 0 °C and let it adjust.
 - Start the adjustment menu and enter the display value at 0 °C for t.oF
 - After leaving the menu, the device should now display 0.0 °C.
- Slope:
- Set the temperature sensor to the reference temperature and let it adjust.
 - Calculate slope correction: $t.SL = \left(\frac{\text{Referenztemperatur}}{\text{Anzeige}} - 1 \right) * 100$
 - Start adjustment menu and enter the calculated value at t.SL
 - Exit menu, the device should now display the reference temperature.

5 Measurement Basics

5.1 Sensor/device accuracy

The device can be equipped with different interchangeable sensors. The temperature sensors are divided into the following classes according to EN 60751.

class	deviation	Temperature range
B	$\pm 0.3 \text{ }^\circ\text{C} \pm 0.5 \%$ of measured value	-50 ... +500 $^\circ\text{C}$
A	$\pm 0.15 \text{ }^\circ\text{C} \pm 0.2 \%$ of measured value	-30 ... +300 $^\circ\text{C}$
AA = 1/3 DIN B	$\pm 0.1 \text{ }^\circ\text{C} \pm 0.17 \%$ of measured value	0 ... +150 $^\circ\text{C}$

In order to achieve high exchange accuracy without the necessity of an additional correction, we recommend using class A or AA temperature sensors.

5.2 Possible measuring errors

5.2.1 Immersion depth

Liquids:

- ▶ Immerse to a depth of at least 20 mm and then stir. Otherwise, measuring errors can occur due to the heat transmission of the sensor tube if the immersion depth is too shallow.

Gas:

- ▶ Immerse as far as possible into the gas to be measured so that the measuring sensor is subjected to a heavy flow.

5.2.2 Surface effects and poor heat transfer

Special measuring sensors are required for this purpose.

Surface characteristics, de-sign of the measuring sensor, heat transfer and environmental temperature influence the measurement result.

Note

Thermally conductive paste between the measuring sensor and surface can also increase measurement accuracy in some cases.

5.2.3 Cooling / evaporation

When measuring the air temperature, the probe should be dry, otherwise the temperature measured will be too low.

5.2.4 Response time

An adequate wait time must be observed for the measuring process before reading the measured value. The response time t_{90} describes the time in which the displayed measured value reached 90% of the end value.

6 Operation and maintenance

6.1 Operating and maintenance notices

Note

- ▶ The device and temperature probe must be handled with care and used in accordance with the technical data. Do not throw or strike.
- ▶ Plugs and sockets must be protected from soiling.
- ▶ If the device is stored at a temperature above 50 °C, or is not used for an extended period of time, the batteries must be removed. Leaks from the batteries are avoided as a result.

6.2 Battery

6.2.1 Battery indicator

If the empty frame in the battery display blinks, the batteries are depleted and must be replaced. However, the device will still operate for a certain length of time.

If the BAT display text appears in the main display, the battery voltage is no longer adequate for operation of the device. The battery is fully depleted.

6.2.2 Changing battery

Danger! Danger of explosion!

Using damaged or unsuitable batteries can generate heat, which can cause the batteries to crack and possibly explode!

- ▶ Only use high-quality and suitable alkaline batteries!

Caution! Damage!

If the batteries have different charge levels, leaks and thus damage to the device can occur.

- ▶ Only use high-quality and suitable alkaline batteries!
- ▶ Do not use different types of batteries!
- ▶ Remove depleted batteries immediately and dispose of them at a suitable collection point.

Note

Unnecessary unscrewing endangers the protection against moisture and should therefore be avoided.

- ▶ Read the following handling instructions before replacing batteries and follow them step by step.
- ▶ If disregarded, the device could be damaged or the protection from moisture could be diminished.

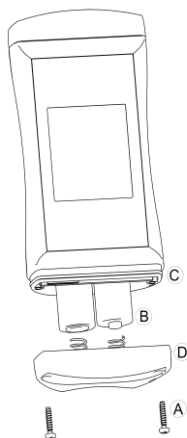

- 1 Unscrews the Phillips screws (A) and remove the cover.
- 2 Carefully replace the two Mignon AA batteries (B). Ensure that the polarity is correct! It must be possible to insert the batteries in the correct position without using force.
- 3 The O-ring (C) must be undamaged, clean and positioned at the intended depth.
- 4 Fit the cover (D) on evenly. The O-ring must remain at the intended depth!
- 5 Tighten the Phillips screws (A).

7 Error and system messages

Display	Meaning	Possible causes	Remedy
----	No suitable measuring probe connected Measurement far outside of the measuring range Sensor cable or probe defect	<ul style="list-style-type: none"> • Incorrect or no measuring probe • Measurement outside of the measuring range • Probe or device defect • Measuring probe or device defect 	<ul style="list-style-type: none"> ▶ Connect a suitable measuring probe Stay within allowable measurement range ▶ Send in for repair ▶ Send in for repair or connect a different probe
No display, unclear characters or no response when buttons are pressed	Battery depleted System error Device is defective	<ul style="list-style-type: none"> • Battery depleted • Error in the device 	<ul style="list-style-type: none"> ▶ Replace battery ▶ Send in for repair
bAt	Battery depleted	<ul style="list-style-type: none"> • Battery depleted 	<ul style="list-style-type: none"> ▶ Replace battery
Err.1	Measuring range exceeded	<ul style="list-style-type: none"> • Measurement too high • Incorrect measuring probe connected • Measuring probe or device defect 	<ul style="list-style-type: none"> ▶ Stay within allowable measurement range ▶ Check measuring probe ▶ Send in for repair
Err.2	Measuring range is undercut	<ul style="list-style-type: none"> • Measurement too low • Incorrect measuring probe connected • Measuring probe or device defect 	<ul style="list-style-type: none"> ▶ Stay within allowable measurement range ▶ Check measuring probe ▶ Send in for repair
545 Err	System error	<ul style="list-style-type: none"> • Error in the device 	<ul style="list-style-type: none"> ▶ Switch device on/off ▶ Replace batteries ▶ Send in for repair

8 Disposal

Separation by material and recycling of device components and packaging must take place at the time of disposal. The valid regional statutory regulations and directives applicable at the time must be observed.

Note



The device must not be disposed of with household waste. Return it to us, freight prepaid. We will then arrange for the proper and environmentally-friendly disposal.

Private end users in Germany have the possibility of dropping off the device at the municipal collection center.

- ▶ Batteries must be removed beforehand!
- ▶ Please dispose of empty batteries at the collection points intended for this purpose

9 Technical data

ECO 120

Measuring range	-200.0 .. +450.0 °C (-328.0 .. +842.0 °F). Observe the permissible range of application of the sensor that is used!
Accuracy	-20 .. +100 °C: $\pm 0.1 \text{ K} \pm 1 \text{ digit}$ Other range: $\pm 0.2 \%$ of measured value $\pm 2 \text{ digits}$ plus sensor deviation (e.g. Class A + sensor cable error)
Probe connection	BNC for Pt1000 temperature sensor (EN 60751)
Measuring cycle	approx. 2 measurements per second
Display	3-line segment LCD, additional symbols, illuminated (white, luminous duration adjustable)
Standard functions	Min/max/hold, alarm (optical and acoustic)
Adjustment	Offset and gradient correction
Housing	Break-proof ABS housing
Protection rating	IP65 / IP67 (only with sensors identified as waterproof in the connected state for devices with BNC socket)
Dimensions L*W*H	108 * 54 * 28 mm, without BNC socket or kink protection
Weight	~ 130 g incl. batteries (ECO 120)
Nominal temperature	25 °C
Operating conditions	-20 to 50 °C; 0 to 95 %RH (temporarily condensing)
Storage temperature	-20 bis 70 °C
Current supply	2 * AA batteries (mignon)
Current requirement	approx. 0.4 mA, approx. 2 mA with backlight
Battery life	Service life > 5000 hours with alkaline batteries (without backlighting)
Battery indicator	4-stage battery status indicator, Replacement indicator for depleted batteries: "BAT"
Auto-power-OFF function	The device switches off automatically if this is activated

Directives and standards	<p>The devices conform to the following Directives of the Council for the harmonization of legal regulations of the Member States:</p> <p>2014/30/EU EMC Directive 2011/65/EU RoHS</p> <p>Applied harmonized standards:</p> <p>EN IEC 61326-1:2021 Emission limits: Class B Immunity according to table 2 Additional errors: < 1 % FS</p> <p>EN IEC 63000:2018</p> <p>The device is intended for mobile use and/or stationary operation in the scope of the specified operating conditions without further limitations.</p>
--------------------------	--

Probe HayTemp

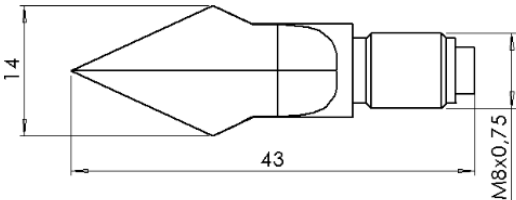
Measuring range	-20,0 .. +120,0 °C (-4,0 .. +248,0 °F)
Accuracy	Class B
Cable	Probe cable 1 m, BNC
 <p>The drawing shows a side view of the probe. It features a conical tip with a diameter of 14 mm. The total length of the probe is 43 mm. The base of the probe is threaded with an M8x0,75 thread.</p>	

10 Service

10.1 Manufacturer

If you have any questions, please do not hesitate to contact us.

10.2 Calibration and adjustment service

The purpose of the calibration is to verify the precision of the measuring device by comparing it with a traceable reference.

Both ISO calibration certificates and DAkkS calibration certificates are available from Senseca.

Explanation

- The ISO standard 9001 is applied for the iso-calibration certificates.
- These certificates are an affordable alternative to the DAkkS calibration certificates and provide information of the traceable reference, a list of individual values and documentation.
- The DAkkS calibration is based on DIN EN ISO/17025, the accreditation basis is recognized worldwide. These certificates offer high-quality calibration and consistently high quality. The DAkkS calibration includes any necessary adjustment with the purpose of minimizing a deviation of the measuring device.
- The device is delivered with a test report.
This confirms that the measuring device has been adjusted and tested, without making any statement about the accuracy of a temperature sensor.
- Only the manufacturer can check the basic settings and make corrections if necessary.

senseca.com



Senseca Germany GmbH
Hans-Sachs-Straße 26
93128 Regenstauf
GERMANY
INFO@SENSECA.COM

WEEE reg. no.: DE 93889386

