



—
your partner
in sensor
technology.

+ User Manual EE431

Duct and Immersion Temperature Sensor



Content

1	General Information.....	3
1.1	Explanation of Warning Notices and Symbols	3
1.2	Safety Instructions	4
1.2.1.	General Safety Instructions	4
1.2.2.	Intended Use.....	4
1.2.3.	Mounting, Start-up and Operation.....	4
1.3	Environmental Aspects.....	5
2	Scope of Supply	5
3	Product Description	5
3.1	General.....	5
3.2	Dimensions	6
3.2.1.	EE431 Duct and Immersion Temperature Sensor	6
3.3	Electrical Connection	6
3.3.1.	Wiring for Active Models	7
3.3.2.	Wiring Diagram for Models with Passive T output.....	9
3.4	Display.....	9
4	Mounting and Installation	9
4.1	Duct Mounting.....	10
4.1.1.	Mounting with flange.....	10
4.1.2.	Minimum Immersion Depth.....	10
4.1.3.	Mounting with Immersion Well.....	10
4.1.4.	Maximum Inflow Velocity on the Immersion Well	11
5	Setup and Configuration	12
5.1	Software	12
5.1.1.	EE-PCS Product Configuration Software	12
5.1.2.	PCS10 Product Configuration Software.....	13
5.2	EE431 analogue with HA011023.....	13
5.3	EE431 analogue with EE-PCA and HA011065	13
5.4	EE431 with RS485 Digital Interface	13
5.4.1.	Hardware Bus Termination	13
5.4.2.	Device Address	14
5.4.3.	BACnet MS/TP Setup	14
5.4.4.	BACnet MS/TP Protocol Settings	14
5.4.5.	Modbus RTU Protocol Settings.....	15
5.4.6.	Modbus Register Map	16
5.4.7.	Modbus RTU Example.....	17
6	Maintenance and Service	17
6.1	Calibration and Adjustment	17
6.1.1.	Definitions	17
6.1.2.	Temperature Calibration and Adjustment.....	18
6.1.3.	Calibration and Adjustment at E+E Elektronik.....	18
6.1.4.	Calibration and Adjustment by the User.....	18
6.2	Repairs and Display Change.....	19
7	Accessories	19
8	Technical Data	20
9	Conformity	22
9.1	Declarations of Conformity.....	22
9.2	FCC Part 15 Compliance Statement	22
9.3	ICES-003 Compliance Statement.....	22

1 General Information

This user manual serves for ensuring proper handling and optimal functioning of the device. The user manual shall be read before commissioning the equipment and it shall be provided to all staff involved in transport, installation, operation, maintenance and repair. E+E Elektronik Ges.m.b.H. does not accept warranty and liability claims neither upon this publication nor in case of improper treatment of the described products.

This document may contain technical inaccuracies and typographical errors. The content will be revised on a regular basis. These changes will be implemented in later versions. The described product(s) can be improved and changed at any time without prior notice.

The user manual may not be used for the purposes of competition without the written consent of E+E Elektronik Ges.m.b.H. and may not be forwarded to third parties. Copies may be made for internal purposes. All information, technical data and diagrams included in these instructions are based on the information available at the time of writing.

PLEASE NOTE

Find this document and further product information on our website at www.epluse.com/ee431.

1.1 Explanation of Warning Notices and Symbols

Safety precautions

Precautionary statements warn of hazards in handling the device and provide information on their prevention. The safety instruction labeling is classified by hazard severity and is divided into the following groups:

DANGER

Danger indicates hazards for persons. If the safety instruction marked in this way is not followed, the hazard will very likely result in severe injury or death.

WARNING

Warning indicates hazards for persons. If the safety instruction marked in this way is not followed, there is a risk of injury or death.

CAUTION

Caution indicates hazards for persons. If the safety instruction marked in this way is not followed, minor or moderate injuries may occur.

NOTICE

Notice signals danger to objects or data. If the notice is not observed, damage to property or data may occur.

Informational notes

Informational notes provide important information which stands out due to its relevance.

INFO

The information symbol indicates tips on handling the device or provides additional information on it. The information is useful for reaching optimal performance of the device.

The title field can deviate from "INFO" depending on the context. For instance, it may also read "PLEASE NOTE".

1.2 Safety Instructions

1.2.1. General Safety Instructions

NOTICE

Improper handling of the device may result in its damage.

- Avoid any unnecessary mechanical stress and inappropriate use.
- Installation, electrical connection, maintenance and commissioning shall be performed by qualified personnel only.
- Use the temperature sensors only as intended and observe all technical specifications.
- The device is designed for operation with class III supply (EU) and class 2 supply (NA).
- Do not apply the supply voltage to the RS485 data lines.

1.2.2. Intended Use

The EE431 duct and immersion temperature sensor is optimized for reliable and accurate temperature monitoring in air and liquids within the specified temperature range (refer to datasheet www.epluse.com/ee431). Typical applications for the sensor are building automation, HVAC and process control.

Apply the mounting and installation methods described in chapter 4 Mounting and Installation.

WARNING

The manufacturer cannot be held responsible for damages as a result of incorrect handling, installation, and maintenance of the device.

- Do not use the temperature sensors in explosive atmosphere or for measurement of aggressive gases.
- This device is not appropriate for safety, emergency stop or other critical applications where device malfunction or failure could cause injury to human beings.
- The device may not be manipulated with tools other than specifically described in this manual.

NOTICE

Failing to follow the instructions in this user manual may lead to measurement inaccuracy and device failures.

- The EE431 may only be operated under the conditions described in this user manual and within the specification included in chapter 8 Technical Data.
- Unauthorized product modification leads to loss of all warranty claims. Modification may be accomplished only with an explicit permission of E+E Elektronik Ges.m.b.H.!

1.2.3. Mounting, Start-up and Operation

The EE431 has been produced under state of the art manufacturing conditions, has been thoroughly tested and has left the factory after fulfilling all safety criteria. The manufacturer has taken all precautions to ensure safe operation of the device. The user must ensure that the device is set up and installed in a way that does not impair its safe use. The user is responsible for observing all applicable local and international safety guidelines for safe installation and operation of the device. This user manual contains information and warnings that must be observed by the user in order to ensure safe operation.

PLEASE NOTE

The manufacturer or his authorized agent can be only be held liable in case of willful or gross negligence. In any case, the scope of liability is limited to the corresponding amount of the order issued to the manufacturer. The manufacturer assumes no liability for damages incurred due to failure to comply with the applicable regulations, operating instructions or the specified operating conditions. Consequential damages are excluded from the liability.

⚠ WARNING

Non-compliance with the product documentation may cause safety risk for persons (accidents, personal injury) or damage to property (measurement installation).

- Mounting, installation, commissioning, start-up, operation and maintenance of the device may be performed by qualified staff only. Such staff must be authorized by the operator of the facility to carry out the mentioned activities.
- The qualified staff must have read and understood this user manual and must follow the instructions contained within.
- All process and electrical connections shall be thoroughly checked by authorized staff before putting the device into operation.
- Do not install or start-up a device supposed to be faulty. Make sure that such devices are not accidentally used by marking them clearly as faulty.
- A faulty device may only be investigated and possibly repaired by qualified, trained and authorized staff. A faulty device shall be removed from the process.
- Service operations other than described in this user manual may only be performed by the manufacturer.

1.3 Environmental Aspects

i PLEASE NOTE

Products from E+E Elektronik Ges.m.b.H. are developed and manufactured in compliance with all relevant environmental protection requirements. Please observe local regulations for the disposal of the device.



For disposal, the individual components of the device must be separated according to local recycling regulations. The electronics shall be disposed of correctly as electronics waste.

2 Scope of Supply

- Temperature sensor according to ordering code
- Test report according to DIN EN10204-2.2 (for active output only)
- Quick guide (digital interface only)
- Cable gland

3 Product Description

3.1 General

The EE431 duct and immersion sensor reliably measures the temperature (T) in air and liquids. It is optimized for building automation, HVAC and process control. The measured data is available at the voltage or current output, on the RS485 interface with Modbus RTU or BACnet MS/TP protocol and on the optional display. The analogue output can be set to °C or °F. In addition, the EE431 features a wide choice of sensing elements for passive temperature measurement.

3.2 Dimensions

3.2.1. EE431 Duct and Immersion Temperature Sensor

Values in mm (inch)

Temperature sensor

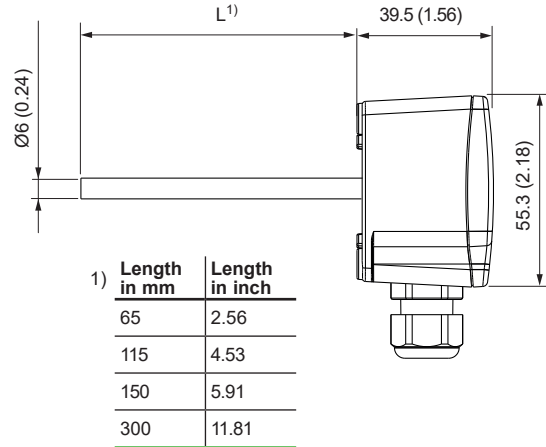
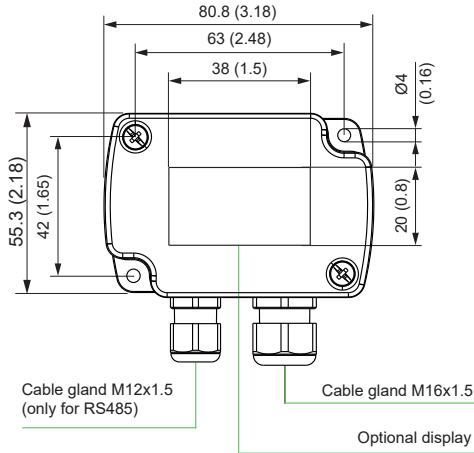

Mounting accessories

Mounting flange

(not included in the scope of supply)

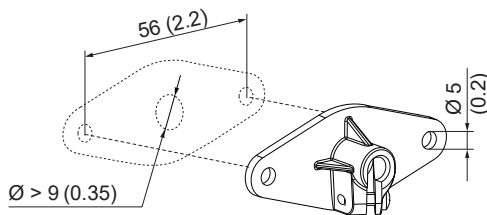

Immersion well

(not included in the scope of supply)

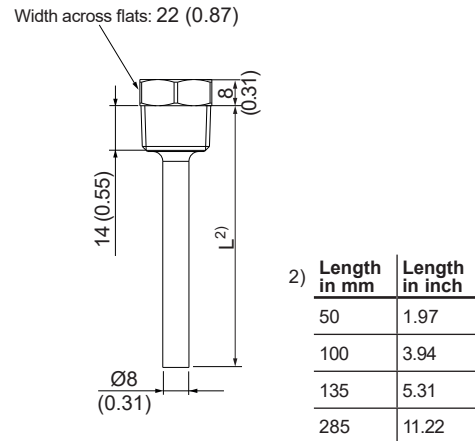

3.3 Electrical Connection

EE431 features screw terminals for connecting the power supply and the outputs. Insert the cables into the enclosure through the M16 cable gland.

NOTICE

It is important to make sure that the cable glands are closed tightly. This is necessary for assuring the IP rating of the enclosure according to EE431 specification, as well as for stress relief at the screw terminals on the EE431 board.

⚠ WARNING

Incorrect installation, wiring or power supply may cause overheating and therefore personal injuries or damage to property.

For correct cabling of the device, always observe the presented wiring diagram for the product version used.

The manufacturer cannot be held responsible for personal injuries or damage to property as a result of incorrect handling, installation, wiring, power supply and maintenance of the device.

3.3.1. Wiring for Active Models

Models with analogue output (0...10V)

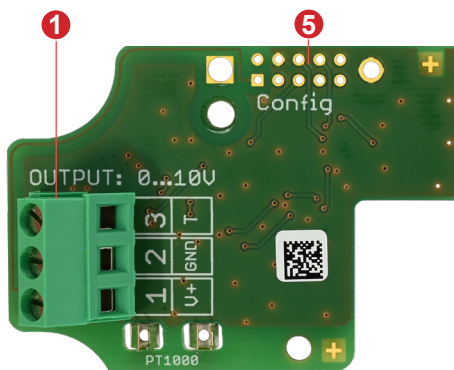
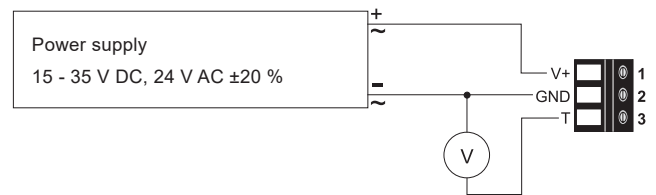
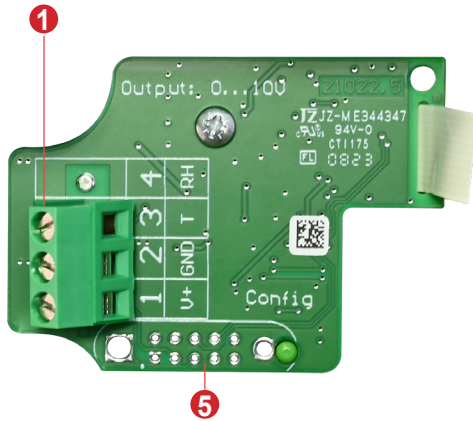

Models with analogue output (4...20mA)

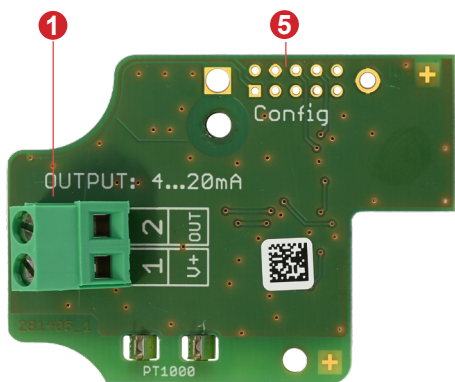
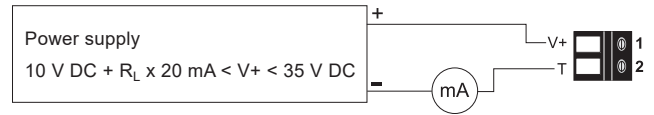
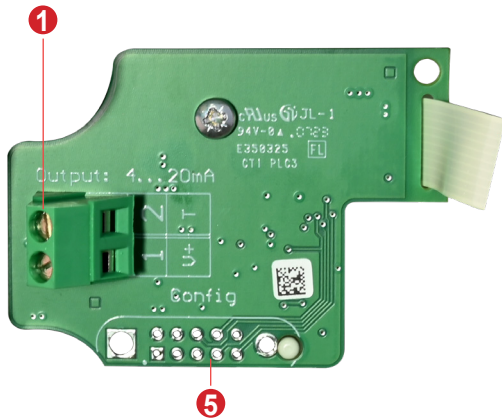

Models with digital interface

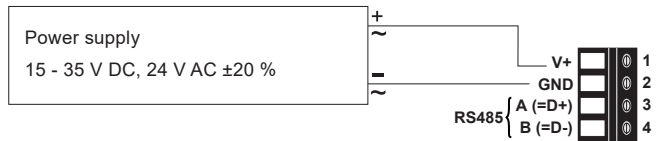
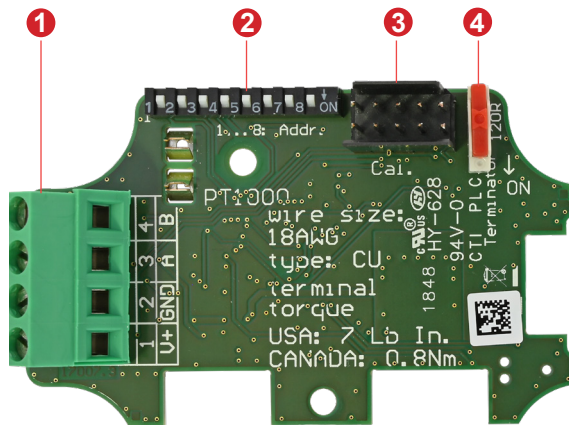

Fig. 1 Temperature sensor connection options

No.	Function
1	Screw terminals for power supply and outputs
2	Address DIP switch for RS485 interface
3	Configuration connector (USB configuration adapter) for RS485 interface
4	Bus termination resistor 120 Ω (jumper)
5	Configuration connector for analogue version

Tab. 1 Part of the digital temperature sensor electronics board types

3.3.2. Wiring Diagram for Models with Passive T output

The unit wiring diagram applies to all passive types. The connections can be interchanged.

2-wire connection

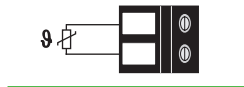

Fig. 2 Temperature sensor connection for passive models

3.4 Display

The single-line LC (Liquid Crystal) display is only available for the active models with analogue output (according to ordering code see datasheet www.epluse.com/ee431).

Depending on the order code, the measured data is displayed in °C or °F. The displayed unit can be changed with the free PCS10 Product Configuration Software, refer to chapter 5 Setup and Configuration for further details.



EE431 set for °F



EE431 set for °C

4 Mounting and Installation

NOTICE

Improper handling of the device may result in its damage.

- Assembly and installation may only be carried out by qualified personnel.

NOTICE

Failing to follow the instructions in this user manual may lead to measurement inaccuracy and device failures.

- For accurate measurement it is essential that the temperature of the sensor is the same as the temperature of the air to measure.
- Mount the temperature sensor at representative locations of the space to be monitored (see Fig. 3 and Fig. 5).
- The sensor may not be exposed to extreme mechanical stress.

For best accuracy please observe the following general mounting instructions and recommended mounting positions.

4.1 Duct Mounting

4.1.1. Mounting with flange

- Mount the sensor about one meter from the inlet
- Mount the probe in a way, that the probe tip is placed in the middle of the duct

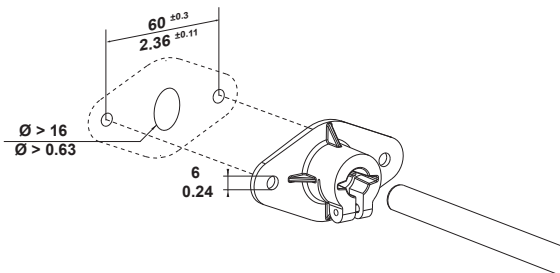

Fig. 3 Correct position of the probe in a flange

4.1.2. Minimum Immersion Depth

Placement options

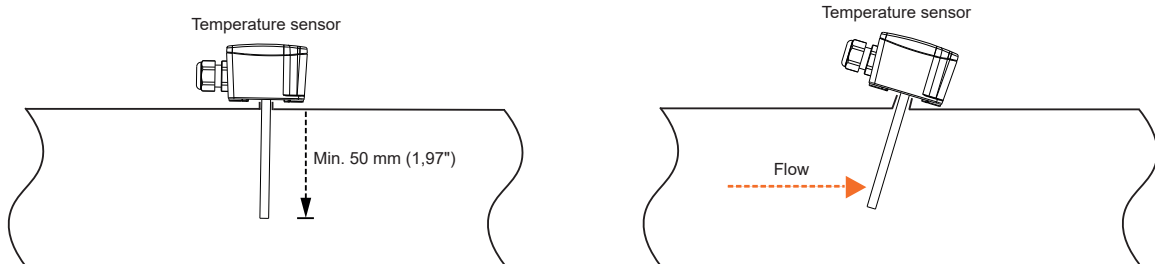

Fig. 4 Correct position in a pipe

4.1.3. Mounting with Immersion Well



Fig. 5 Handling of the immersion well

Procedure:

1. The spring inside the well must be removed and replaced by a standard M12x1.5 cable gland (not included in the scope of supply).
2. Insert the sensor and fix it by fastening the cable gland.

NOTICE

Observe the operating temperature range of the cable gland to match the process parameters.

i PLEASE NOTE

- For installation avoid regions of high turbulences (e.g. after fittings)
- Mount the sensor in the opposite direction to flow (see the picture Correct Position below)

Correct Position

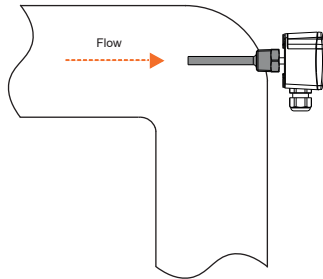

Incorrect Position

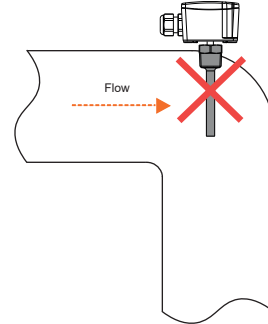

Fig. 6 Position of the probe in the pipe with immersion well

4.1.4. Maximum Inflow Velocity on the Immersion Well

Immersion Well Length	Brass	Stainless Steel
50 mm (1.97")	26 m/s (5118 ft/min)	29 m/s (5708 ft/min)
100 mm (3.94")	12 m/s (2362 ft/min)	15 m/s (2953 ft/min)
135 mm (5.31")	6 m/s (1181 ft/min)	9 m/s (1771 ft/min)
285 mm (11.22")	1 m/s (197 ft/min)	2 m/s (394 ft/min)

Tab. 2 Maximal inflow velocity

5 Setup and Configuration

The temperature sensor is ready to use and does not require any configuration by the user. The factory setup corresponds to the type number ordered. For ordering guide please refer to the datasheet at www.epluse.com/ee431. The user can change the factory setup with the free Product Configuration Software and corresponding accessories (see Tab. 3 Configuration accessories).

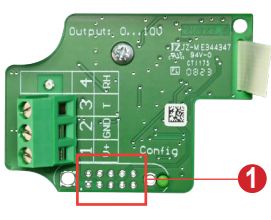
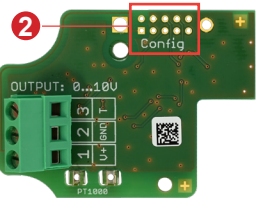
Sensor Models		Configuration with	
		EE-PCS	PCS10
Analogue 0 - 10 V / 4 20 mA			HA011023
Analogue 0 - 10 V / 4 20 mA		EE-PCA with HA011065	
Digital version	EE431-M3J3	HA011066	

Tab. 3 Configuration accessories

No.	Description
1	Plug in the configuration adapter at the bottom
2	Plug in the configuration adapter on the top

Tab. 4 Positioning of the configuration adapter

5.1 Software

5.1.1. EE-PCS Product Configuration Software

For sensor adjustment and for changing the settings, please proceed as follows:

1. Download the EE-PCS Product Configuration Software from www.epluse.com/configurator and install it on the PC.
2. Connect the E+E device to the PC using the appropriate configuration adapter.
3. Start the EE-PCS software.
4. Follow the instructions on the EE-PCS opening page for scanning the ports and identifying the connected device.
5. Click on the desired setup or adjustment mode from the main EE-PCS menu on the left and follow the online instructions of the EE-PCS.

5.1.2. PCS10 Product Configuration Software

For sensor adjustment and for changing the settings, please proceed as follows:

1. Download the PCS10 Product Configuration Software from www.epluse.com/pcs10 and install it on the PC.
2. Connect the E+E device to the PC using the USB configuration adapter.
3. Start the PCS10 software.
4. Follow the instructions on the PCS10 opening page for scanning the ports and identifying the connected device.
5. Click on the desired setup or adjustment mode from the main PCS10 menu on the left and follow the online instructions of the PCS10.

5.2 EE431 analogue with HA011023

Use the PCS10 and the HA011023 USB Configuration Adapter for EE431 with analogue output. An external power supply according to the technical data is required. The power supply adapter V03 is suitable. As soon as the device is connected to the adapter, the display shows CAL.

With the PCS10, the output scaling, the output measuring unit and the displayed unit (°C or °F) can be changed.

Upper and lower thresholds can be set up for the measurands. The display flashes at one-second interval for measured T beyond the range.

An offset (Fig. 11) and a 1- or 2-point adjustment (Fig. 12) can be performed, as well as a reset to the factory adjustment and settings. Besides, the configuration settings can also be exported or imported.

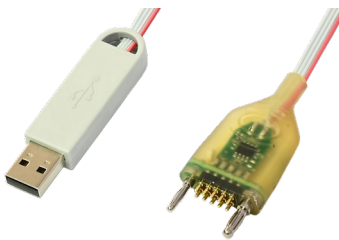

Fig. 7 HA011023 USB Configuration Adapter for EE431 with analogue output

5.3 EE431 analogue with EE-PCA and HA011065

Use the EE-PCS and EE-PCA with the connection cable HA011065. For further details see datasheet EE-PCA (available at www.epluse.com/ee431).

With the PCS10, the output scaling, the output measuring and the displayed unit (°C or °F) can be changed.

An offset (Fig. 11) and a 1- or 2-point adjustment (Fig. 12) can be performed, as well as a reset to the factory adjustment and settings. Besides, the configuration settings can also be exported or imported.

5.4 EE431 with RS485 Digital Interface

Use the EE-PCS and the USB configuration adapter HA011066.

With the EE-PCS, an offset adjustment (Fig. 11) and 1- or 2-point adjustment (Fig. 12) can be performed.

The temperature adjustment can be reset to the factory settings. In addition, further digital configuration settings can be made (see below).

5.4.1. Hardware Bus Termination

The bus termination can be realized with 120 Ω resistor (slide switch on the board).

5.4.2. Device Address

Address Switch



Address setting via EE-PCS Product Configuration Software

All DIP switches at position 0 → address has to be set via EE-PCS. (*factory setting*)

Modbus (slave device):

Factory setting 66 (permitted values: 1...247).

BACnet (master device):

Factory setting 66 (permitted values: 0...127).

Example: 0000 0000 = Address is set via configuration software.

Address Switch



Address setting via DIP switch

Modbus (slave device): Setting the DIP switches to any other address than 0, overrules the Modbus address set via EE-PCS (permitted values: 1...247).

BACnet (master device): Setting the DIP switches to any other address than 0, overrules the BACnet address set via configuration software.

BACnet Note: permitted values are 0...127. The 8th bit of the DIP switches is ignored (ID 127 = 0111 111). To set address 0 via DIP switches, the 8th bit shall be set to 1 (ID 0 = 1000 0000).

Example: 0000 1011 binary = Address set to 11.

5.4.3. BACnet MS/TP Setup

Refer to PICS (Product Implementation Conformance Statement) - available on www.epluse.com/ee431.

5.4.4. BACnet MS/TP Protocol Settings

	Factory settings	User selectable values (via EE-PCS / BACnet MS/TP protocol)
Baud rate	As per type number ordered	9 600, 19 200, 38 400, 57 600, 76 800, 115 200
Data bits	8	8
Parity	None	None
Stop bits	1	1
BACnet address	66	0...127

Tab. 5 BACnet protocol settings

i PLEASE NOTE

The recommended settings for multiple devices in a BACnet MS/TP network are 38 400, 8, none, 1.

The EE4x1D PICS (Product Implementation Conformance Statement) are available on the E+E website at www.epluse.com/ee431.

BACnet address and baud rate can be set via:

- EE-PCS Product Configuration Software and the USB configuration adapter HA011066.
- BACnet protocol, see the PICS.

5.4.5. Modbus RTU Protocol Settings

	Factory settings	User selectable values (via EE-PCS / Modbus protocol)
Baud rate	As per type number ordered	9 600, 19 200, 38 400
Data bits	8	8
Parity	Even	None, odd, even
Stop bits	1	1, 2
Modbus address	66	1...247

Tab. 6 Modbus RTU protocol settings

i PLEASE NOTE

The recommended settings for multiple devices in a Modbus RTU network are 9 600, 8, even, 1.

Device address, baud rate, parity and stop bits can be set via:

- EE-PCS Product Configuration Software and the USB configuration adapter HA011066. The EE-PCS10 can be downloaded free of charge from www.epluse.com/configurator.
- Modbus protocol in the register 1 (0x00) and 2 (0x01). See Application Note Modbus AN0103 (available at www.epluse.com/ee431).

The measured values are saved as 32 bit float value (FLOAT32) and 16 bit signed integer (INT16). The factory setting for the Modbus address is 66 as an INT16 value. This address can be changed by the user in the register 1 (0x00), permitted values are 1...247.

The serial number as ASCII-code is located in read-only registers 1 - 8 (0x00 - 0x07, 16 bits per register). The firmware version is located in register 9 (0x08) (bit 15...8 = major release; bit 7...0 = minor release). The sensor name as ASCII-code is located in read-only registers 10 - 17 (0x09 - 0x11, 16 bits per register).

NOTICE

When reading the serial number or the sensor name, it is always necessary to read all 8 registers, even if the desired information requires less.

NOTICE

For obtaining the correct floating point values, both registers have to be read within the same reading cycle. The measured value can change between two Modbus requests, exponent and mantissa may get inconsistent then.

Communication settings (INT16)

Parameter	Register number ¹⁾ [Dec]	Register address ²⁾ [Hex]
Write register: function code 0x06		
Modbus address ³⁾	1	0x00
Modbus protocol settings ⁴⁾	2	0x01

Device information (INT16)

Parameter	Register number ¹⁾ [Dec]	Register address ²⁾ [Hex]
Read register: function code 0x03 / 0x04		
Serial number (as ASCII)	1	0x00
Firmware version	9	0x08
Sensor name (as ASCII)	10	0x09

1) Register number starts from 1.

2) Protocol address starts from 0.

3) If the address is set via DIP switch, the response will be NAK.

4) For Modbus address and protocol settings see Application Note Modbus AN0103 (available at www.epluse.com/ee431).

Tab. 7 Digital sensors' registers for device setup

5.4.6. Modbus Register Map

The measured data is saved as 32 bit floating point values (FLOAT32) and as 16 bit signed integer values (INT16).

FLOAT32

Measurand	Unit ¹⁾	Register number ²⁾ [DEC]	Register address ³⁾ [HEX]
Read register: function code 0x03 / 0x04			
Temperature	°C	1003	0x3EA
Temperature	°F	1005	0x3EC
Temperature	°K	1009	0x3F0

INT16

Measurand	Unit ¹⁾	Scale ⁴⁾	Register number ²⁾ [DEC]	Register address ³⁾ [HEX]
Read register: function code 0x03 / 0x04				
Temperature	°C	100	4002	0xFA1
Temperature	°F	50	4003	0xFA2
Temperature	K	50	4005	0xFA4

1) The choice of measurement units (metric or non-metric) must be done according to the ordering guide, see EE431 datasheet. Switching from metric to non-metric or vice versa by using the EE-PCS is not possible.

2) Register number starts from 1

3) Register address starts from 0

4) Examples: For scale 100, the reading of 2550 means a value of 25.5. For scale 50, the reading of 2550 means a value of 51.

Tab. 8 FLOAT32 and INT16 measured data registers

5.4.7. Modbus RTU Example

Example of Modbus RTU command for reading the Temperature (float value) T = 26,953624 °C from the register 0x3EA.

Device EE431; Modbus address 66 [42 in HEX]

Reference document (chapter 6.3): http://www.modbus.org/docs/Modbus_Application_Protocol_V1_1b.pdf.

Read the temperature (FLOAT32) T from register address 0x3EA:

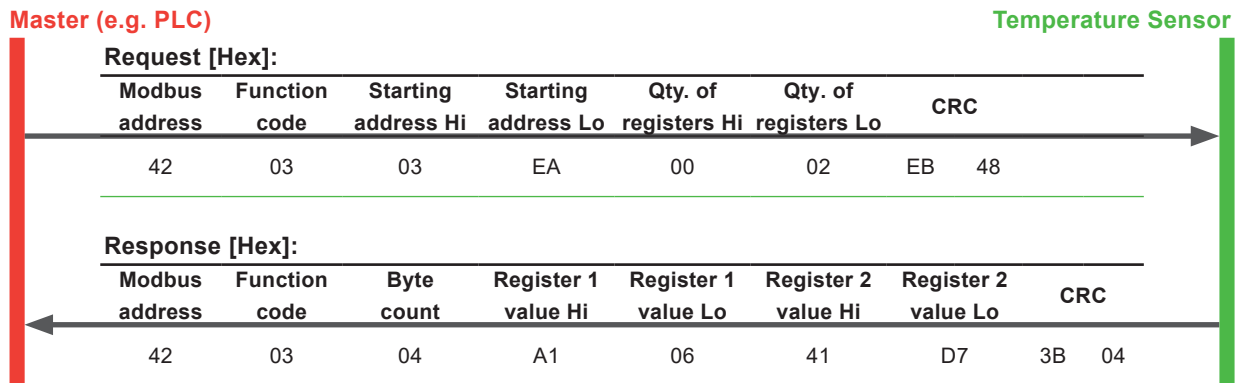

Fig. 8 Example temperature query

Decoding of floating point values:

Floating point values are stored according to IEEE754. The byte pairs 1, 2 and 3, 4 are transformed as follows (numbers taken from T reading Modbus request/response example, Fig. 8):

Modbus response [Hex]

Register 1 Hi	Register 1 Lo	Register 2 Hi	Register 2 Lo
A1	06	41	D7
MMMMMMMM	MMMMMMMM	SEEEEEEE	EMMMMMMM

Fig. 9 Modbus response

IEEE754

Register 2 Hi	Register 2 Lo	Register 1 Hi	Register 1 Lo
41	D7	A1	06
0100 0001	1101 0111	1010 0001	0000 0110
SEEE EEEE	EMMM MMMM	MMMM MMMM	MMMM MMMM
Decimal value: 26.953624725341796875			

Fig. 10 Data representation according to IEEE754

6 Maintenance and Service

6.1 Calibration and Adjustment

6.1.1. Definitions

Calibration: The specimen is compared with a reference and its deviation from the reference is documented.

Adjustment: The specimen is brought in line with the reference.

6.1.2. Temperature Calibration and Adjustment

Depending on the application and the requirements of certain industries, there might arise the need for periodical temperature calibration or adjustment.

6.1.3. Calibration and Adjustment at E+E Elektronik

Calibration and/or adjustment can be performed in the E+E Elektronik calibration laboratory. For information on the E+E capabilities in ISO or accredited calibration please see www.eplusecal.com.

6.1.4. Calibration and Adjustment by the User

Depending on the level of accuracy required, the temperature reference can be:

- Liquid bath calibrator
- Dry block calibrator
- Climate chamber
- Handheld device (e.g. Omniport30), please see www.epluse.com/omniport30.

Perform offset and 1- or 2-point adjustment via the E+E Product Configuration Software (see below).

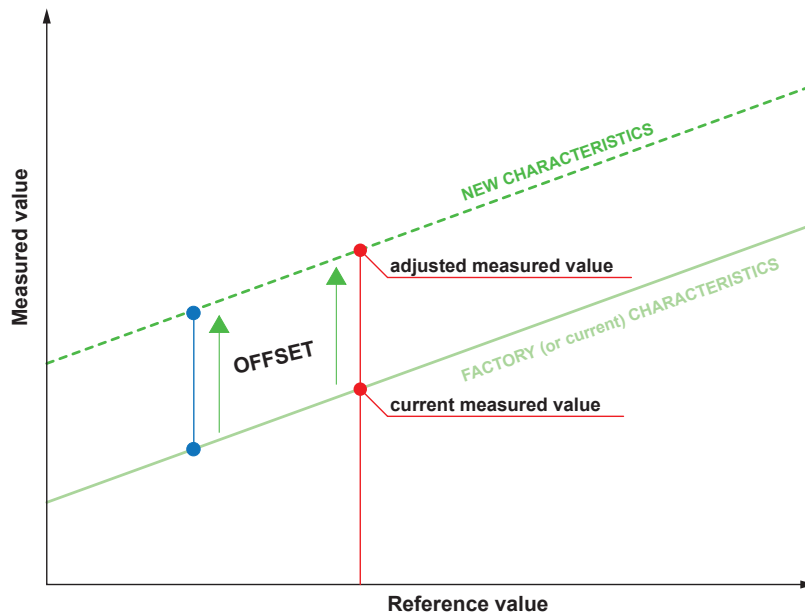

Fig. 11 Offset adjustment

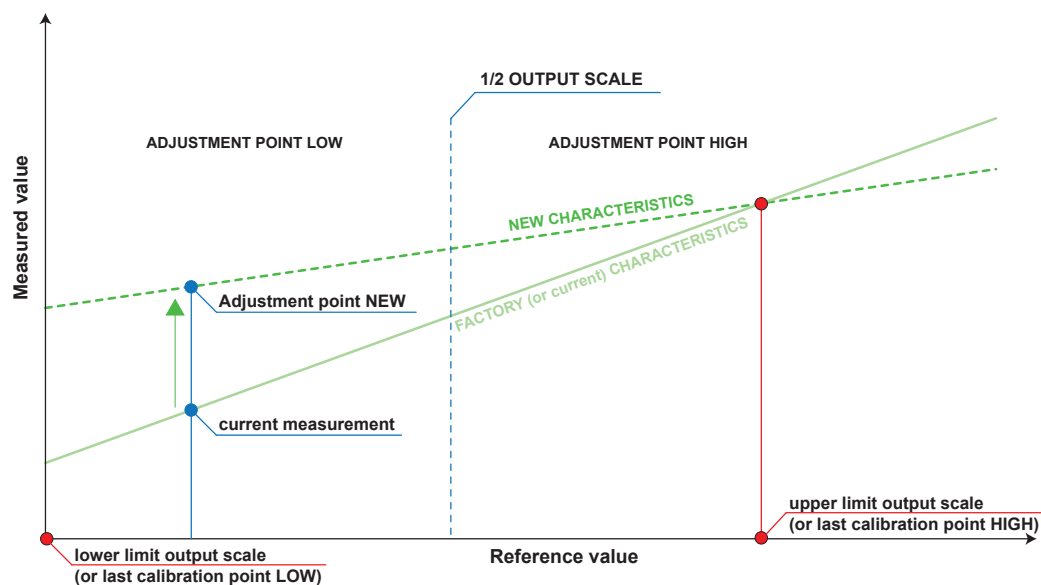

Fig. 12 1- or 2-point adjustment

6.2 Repairs and Display Change

i PLEASE NOTE

Repairs may be carried out by the manufacturer only. The attempt of unauthorized repair excludes any warranty claims.

7 Accessories

For further information see datasheet [Accessories](#).

Description		Code			
Product configuration adapter for 4 - 20 mA version without display (Available at EE-PCA)		See datasheet EE-PCA			
Configuration adapter for display and 0 - 10 V versions without display		HA011023			
USB configuration adapter for digital output		HA011066			
E+E Product Configuration Software for digital output and for 4 - 20 mA version without display (Free download: www.epluse.com/configurator)		EE-PCS			
E+E Product Configuration Software (Free download: www.epluse.com/pcs10) for display and 0 - 10 V versions without display		PCS10			
Power supply adapter for digital output		V03			
Conduit Adapter, M16x1.5 auf 1/2"		HA011110			
Mounting flange		HA401101			
Immersion well - thread R ½" ISO	Length in mm (inch)	50 (1.97")	100 (3.94")	135 (5.31")	285 (11.22")
	Brass	HA400101	HA400104	HA400102	HA400103
	Stainless steel	HA400201	HA400204	HA400202	HA400203
Immersion well - thread ½" NPT	Length in mm (inch)	50 (1.97")	100 (3.94")	135 (5.31")	285 (11.22")
	Brass	HA400111	HA400114	HA400112	HA400113
	Stainless steel	HA400211	HA400214	HA400212	HA400213

8 Technical Data

Measurands

Temperature (T) - Active

Measuring range	Duct sensor (probe tip)	-40 °C...+110 °C (-40...+230 °F)
	With immersion well (probe tip)	-40 °C...+130 °C (-40...+266 °F)
Accuracy @ 20 °C (68 °F)		±0.25 °C (0.36 °F)
	Optional for analogue output	±0.1 °C (±0.18 °F) ¹⁾

1) Uncertainty of factory calibration at 20 °C ±0.1 °C (68 °F ±0.18 °F).

Temperature (T) - Passive

Measuring range	Duct sensor	-40 °C...+110 °C (-40...+230 °F)		
	Immersion Sensor with Pt and Ni T sensor	-40 °C...+150 °C (-40...+302 °F)		
Sensor type	Nominal resistance	Sensitivity	Standard	
	Pt100 DIN B	R ₀ : 100 Ω	TC: 3.850 x 10 ⁻³ /°C	DIN EN 60751
	Pt1000 DIN B	R ₀ : 1000 Ω	TC: 3.850 x 10 ⁻³ /°C	DIN EN 60751
	NTC10k B3950	R ₂₅ : 10 kΩ ±0.5 %	B _{25/85} : 3989 K (B _{25/50} : 3950 K ± 1.0 %)	-
	NTC20k B4286	R ₂₅ : 20 kΩ ± 0.2 °C	B _{25/85} : 4286 K (B _{25/85} : 4286 K ± 1.0 %)	-
	Ni1000 TK6180 DIN B	R ₀ : 1000 Ω	TC: 6180 ppm/K	DIN 43760
	Ni1000 TK5000 DIN B	R ₀ : 1000 Ω	TC: 5000 ppm/K	DIN 43760

Outputs

Analogue

Analogue output	0 - 10 V 4 - 20 mA (2-wire)	-1mA < I _L < 1 mA R _L ≤ 500 Ω	I _L = load current R _L = load resistance
------------------------	--------------------------------	--	---



Digital

Digital interface	RS485 (EE431 = 1 Unit Load)
Protocol Factory settings Supported Baud rates Measured data types	Modbus RTU Baud rate see order information, data bits 8, parity even, 1 stop bit, Modbus address 66 9 600, 19 200 und 38 400 FLOAT32 and INT16
Protocol Factory settings Supported Baud rates	BACnet MS/TP Baud rate see order information, data bits 8, parity none, 1 stop bit, BACnet address 66 9 600, 19 200, 38 400, 57 600, 76 800 und 115 200

T Sensor Passive

Sensor connection	2-wire connection
Measuring current, typ.	<1 mA (according to technical data of the specific T sensing element)

General

Power supply class III  USA & Canada: Class 2 supply necessary, max. voltage 30 V DC for output RS485 and 0 - 10 V for output 4 - 20 mA		15 - 35 V DC or 24 V AC $\pm 20\%$ $10\text{ V DC} + R_L \times 20\text{ mA} < V_+ < 35\text{ V DC}$ $R_L = \text{load resistance}$					
Current consumption, @ 24 V	Voltage output	DC supply max. 0.8mA AC supply max. 4.6 mA _{rms}	with display max. 1.7 mA with display max. 7 mA _{rms}				
	Current output	According to output current	According to output current				
	Digital interface	DC supply typ. 3.5 mA AC supply typ. 12 mA _{rms}					
Electrical connection		Screw terminals max. 2.5 mm ² (AWG14)					
Cable glands		M16x1.5 / M12x1.5 / UL94 V-2					
Insulation resistance (probe) @20 °C (68 °F)		>100 MΩ					
LC-display		Available for output A3 and A6 1 line, switchable between °C / °F or according to order code Without backlight Visible area 38 mm x 20 mm (1.5" x 0.8")					
Response time t₆₃ Duct sensor at 3 m/s (590 ft/min) air velocity Immersion sensor in liquid water bath		<1 min <30 s					
Humidity working range		5...95 %RH, non-condensing					
Temperature working range		Duct sensor (probe tip)	With immersion well (probe tip) Active		Passive	Electronics without Display	Electronics with Display
		-40...+110 °C (-40...+230 °F)	-40...+130 °C (-40...+266 °F)	-40 °C...+150 °C (-40...+302 °F)	-40...+70 °C (-40...+158 °F)	-20...+50 °C (-4...+122 °F)	
Storage conditions		Without display	-30...+70 °C (-22...+158 °F) 5...95 %RH, non-condensing				
		With display	-20...+50 °C (-4...+122 °F) 5...95 %RH, non-condensing				
Probe material		Stainless steel (1.4571 / 316Ti)					
Enclosure		Polycarbonate (PC), UL94 V-0 approved IP65 / NEMA 4X					
Material Protection rating							
Electromagnetic compatibility		EN 61326-1	EN 61326-2-3	Industrial environment			
		FCC Part15 Class B	ICES-003 Class B				
Conformity		 					
Configuration and adjustment For display and 0 - 10 V		PCS10 Product Configuration Software (free download: www.epluse.com/pcs10) and configuration adapter.					
For digital and 4 - 20 mA version without display		EE-PCS Product Configuration Software (free download: www.epluse.com/configurator) and configuration adapter.					

9 Conformity

9.1 Declarations of Conformity

E+E Elektronik Ges.m.b.H. hereby declares that the product complies with the respective regulations listed below:



European directives and standards.

and



UK statutory instruments and designated standards.

Please refer to the product pages at www.epluse.com/ee431 for the Declarations of Conformity.

9.2 FCC Part 15 Compliance Statement

This equipment has been tested and found to comply with the limits for a Class B digital device, pursuant to part 15 of the FCC Rules. These limits are designed to provide reasonable protection against harmful interference in a residential installation. This equipment generates, uses and can radiate radio frequency energy and, if not installed and used in accordance with the installation manual, may cause harmful interference to radio communications. However, there is no guarantee that interference will not occur in a particular installation. If this equipment does cause harmful interference to radio or television reception, which can be determined by turning the equipment off and on, the user is encouraged to try to correct the interference by one or more of the following measures:

- Reorient or relocate the receiving antenna.
- Increase the separation between the equipment and receiver.
- Connect the equipment into an outlet on a circuit different from that to which the receiver is connected.
- Consult the dealer or an experienced radio/TV technician for help.

9.3 ICES-003 Compliance Statement

This Class B digital apparatus complies with Canadian ICES-003.

Cet appareil numérique de la classe B est conforme à la norme NMB-003 du Canada.



Company Headquarters &
Production Site

E+E Elektronik Ges.m.b.H.
Langwiesen 7
4209 Engerwitzdorf | Austria
T +43 7235 605-0
F +43 7235 605-8
info@epluse.com
www.epluse.com

Subsidiaries

E+E Sensor Technology (Shanghai) Co., Ltd.
T +86 21 6117 6129
info@epluse.cn

E+E Elektronik France SARL
T +33 4 74 72 35 82
info.fr@epluse.com

E+E Elektronik Deutschland GmbH
T +49 6171 69411-0
info.de@epluse.com

E+E Elektronik India Private Limited
T +91 990 440 5400
info.in@epluse.com

E+E Elektronik Italia S.R.L.
T +39 02 2707 86 36
info.it@epluse.com

E+E Elektronik Korea Ltd.
T +82 31 732 6050
info.kr@epluse.com

E+E Elektronik Corporation
T +1 847 490 0520
info.us@epluse.com



—
your partner
in sensor
technology.