

Operating Instructions



HYDROMETTE *BL* COMPACT B



GANN MESS- U. REGELTECHNIK GMBH

70839 GERLINGEN

SCHILLERSTRASSE 63

INTERNET: <http://www.gann.de>

Verkauf National: TELEFON 07156-4907-0
Verkauf International TELEFON +49 7156-4907-0

TELEFAX 07156-4907-40
TELEFAX +49 7156-4907-48

EMAIL verkauf@gann.de
EMAIL sales@gann.de

Contents

0.1	Publication Declaration	4
0.2	General Information	5
0.3	WEEE Directive 2002/96/EC Electrical and Electronic Equipment Act	6
1	Introduction	7
1.1	Description	7
1.2	Instrument Design and Key Assignments	8
1.3	Display Icons	9
2	Basic Functions	10
2.1	Switching the Instrument On	10
2.2	Display in Measuring Mode	11
2.3	Settings Menus	12
2.3.1	Measuring Menu (main menu)	12
2.3.2	Material Settings	13
2.3.3	Alarm Value Setting	14
2.3.4	Maximum Value	15
2.4	Measurement Menu with Tendency Indicator (only for measuring wood)	18
2.5	Additional Functions	19
2.5.1	Automatic Shut-down	19
2.5.2	Battery Monitoring	19
3	Specifications	20
3.1	Technical Specifications	20
3.2	Intolerable Ambient Conditions	20
3.3	Measuring Range	21

4	Notes on Use	22
4.1	General Notes	22
4.2	Orientation Values	23
4.3	Handling the Hydromette BL Compact B	24
4.4	Reading / Conversion Values (digits) in Relation to the Raw Density of the Material	26
5	Annex	28
5.1	Materials Table	28
5.2	Comparison Graph of Humidity - Material Moisture Content	29
→	Illustrated quick-start guide in the middle section	←

0.1 Publication Declaration

This publication replaces all previous versions. It may not be reproduced or electronically processed, duplicated or distributed in any way without the written permission of Gann Mess- u. Regeltechnik GmbH. Subject to technical and documentary change. All rights reserved. This document was compiled with the necessary care. Gann Mess- u. Regeltechnik GmbH accepts no liability whatsoever for errors or omissions.

GANN Mess- u. Regeltechnik GmbH, Gerlingen, 13 Oct. 2009

0.2 General Information

This measuring instrument conforms to the (2004/108/EG) (EN61010) standard and fulfils the requirements of applicable European and national directives. Appropriate declarations and documentation are located with the manufacturer. The user must read these operating instructions in order to guarantee problem-free instrument operation and operational safety. The measuring instrument may only be operated under the specified climatic conditions. These conditions can be found in Section 3.1 "Specifications". In addition, this measuring instrument may only be operated under the conditions and for the purpose it was designed for. The operational safety and functionality are no longer guaranteed if the instrument is modified or converted. Gann Mess-u. Regeltechnik GmbH assumes no liability for any ensuing damage. All risks are assumed solely by the user.

- Use appropriate means to make absolutely sure that the area to be measured contains no electrical wires, plumbing or other supply lines.
- The instrument may not be stored or operated in aggressive atmospheres or atmospheres containing solvents!
- It is not possible to measure material that is frozen or has a wet surface.
- The notes and tables on allowable or common moisture conditions in practice and general definitions given in these instructions were taken from the technical literature. The manufacturer therefore cannot accept any liability for correctness. The conclusions drawn from the

measurement results depend on each user's individual requirements and practical, professional empiricism.

- Because the measuring instrument adheres to the stricter emitted interference (EMC) Class B it may be operated in residential and commercial environments.
- The instrument must not be operated in the immediate vicinity of medical devices (heart pacemakers, etc.).
- The measuring instrument may be used only for the purpose intended, as described in these instructions. The instrument and accessories should be kept away from children!
- Do not measure on metal surfaces.

Gann Mess- u. Regeltechnik GmbH accepts no liability for damage caused by non-compliance with the operating instructions or by violation of a duty to care during transport, storage or operation of the instrument, even if this duty to care is not specifically discussed in the operating instructions.

0.3 WEEE Directive 2002/96/EC Electrical and Electronic Equipment Act

The packaging, battery and instrument must be disposed of at a recycling centre in accordance with legal regulations.

The instrument was manufactured after 01.10.2009

1 Introduction

1.1 Description

The Hydromette BL Compact B is an electronic building moisture meter based on the dielectric-constant / high-frequency measurement principle, with a 3-line LCD display and a flexibly applicable ball probe for non-destructive detection of moisture in all types of building materials, as well as the moisture distribution in walls, ceilings and floors.

An ideal pretesting instrument for all CM devices.

1.2 Instrument Design and Key Assignments



1.3 Display Icons

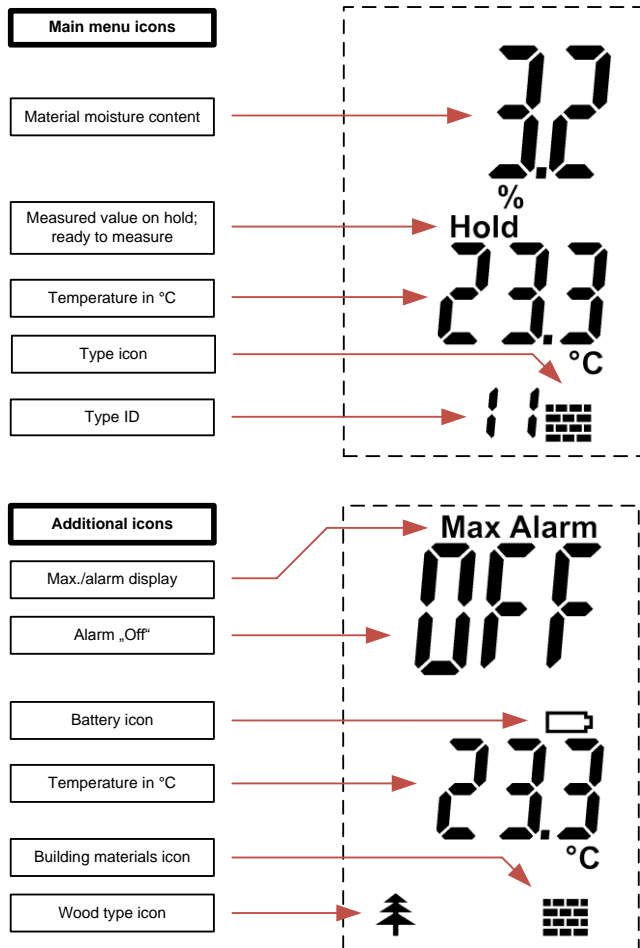

2 Basic Functions

2.1 Switching the Instrument On

Hold the instrument firmly by its bottom half.

Hold the ball electrode in the open air and press the “On” key. 

This will start an automatic zero-point correction. The instrument should not be moved during this calibration.

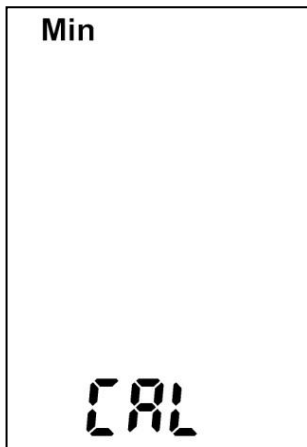

If storage of the minimum value of 0 is signalled, that means that the minimum value of “0” has been set.

Calibration symbol: This indicates that calibration is in progress.

Figure 2-1 Calibration mode

After about 2 seconds, the calibration will end and the instrument will switch to measuring mode.

2.2 Display in Measuring Mode

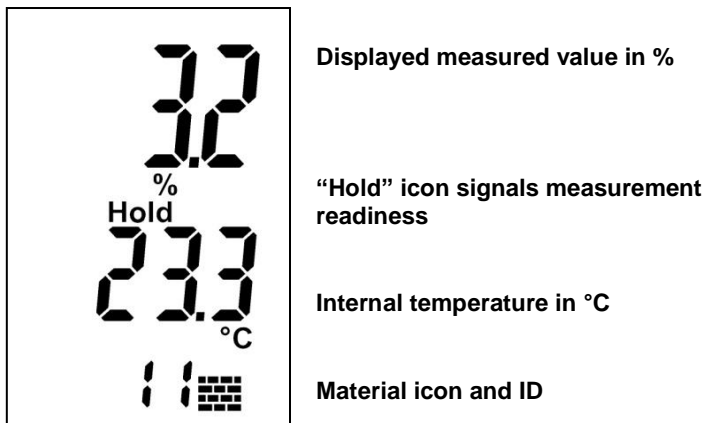

Figure 2-2 Measuring mode

A measuring process is started by pressing the "M" key.

The type ID 0 stands for measurement in "digits". The scale then ranges from 0 to 100, and the percent sign and material icon disappear. This value indication allows quick scanning of large areas for maximum moisture of the extent of moisture damage.

Digital values are dimensionless measurement values and not real moisture values as a percentage!

Measure by pressing the "M" key and placing the ball electrode on the material to be measured.

2.3 Settings Menus

By repeatedly pressing the "Up" and "Down" keys the following menus can be selected in sequence (sequence using the "Down" key; the menus are accessed in the opposite direction using the "Up" key):

1. **Measuring menu** (main menu): The measuring process can be performed from here.
2. **Type selection:** The material type can be selected here.
3. **Alarm value setting:** This allows the user to set a measurement value threshold that will trigger an acoustic signal when exceeded.
4. **Maximum value:** The largest measured value is displayed.

2.3.1 Measuring Menu (main menu)

The last measured value is shown together with the comment "Hold". The instrument temperature and the current type are also shown on the display.

A new measurement can be started in this menu by pressing the "M" key.

The "Hold" icon disappears from the display during the measurement. After the "M" key is released, the measured value is stored. The "Hold" icon is displayed again.

If the new measured value is greater than the previous maximum, "Max" flashes on the display. The "M" key is pressed briefly to store the new value. A new measurement can be started without altering the previous maximum by pressing "M" longer if the value is not to be stored.

If the alarm function is turned on, a warning signal sounds when the adjustable alarm value has been exceeded, and the measurement value flashes. At the same time, the selected alarm value is shown in the third line of the display.

2.3.2 Material Settings

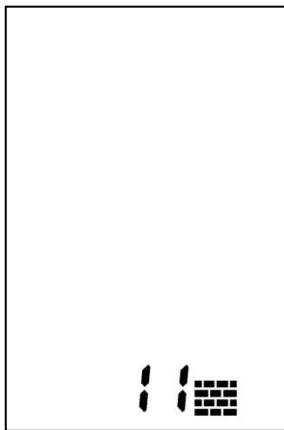

The specified material ID is displayed with the icon for wood moisture or material moisture.

Material icon and ID

Figure 2-3 Material selection

Press the "**M**" key (measure key) *briefly* to change the preset for the material.

The material ID flashes and can be set using the "**Up**" and "**Down**" keys. Press the "**M**" key again *briefly* to save the change.

The material table can be found in the Annex.

2.3.3 Alarm Value Setting

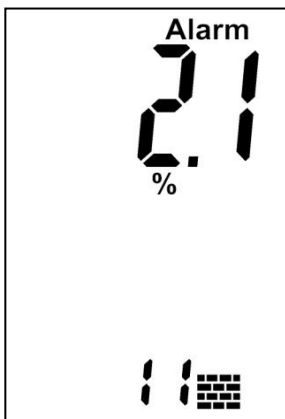

Alarm value setting:

The alarm can be activated or deactivated from this menu. The alarm value can also be set.

Material icon and ID

Figure 2-4 Alarm menu

If no maximum value is stored, or if it is deleted, the “OFF” icon appears.

To enter a new maximum value or to activate the function, *briefly* press the “M” key. The display begins to flash. Pressing *longer* on the “M” key activates the alarm value. The alarm value for each material ID set in measuring mode can be entered separately by using the “Up” and “Down” keys. After the desired value has been set, or a previously available one (re)activated, press *briefly* on the “M” key to confirm the entry. The instrument will return to standby mode.

If 0 is chosen as the material ID, the display will show in digits, without percentage data.

2.3.4 Maximum Value

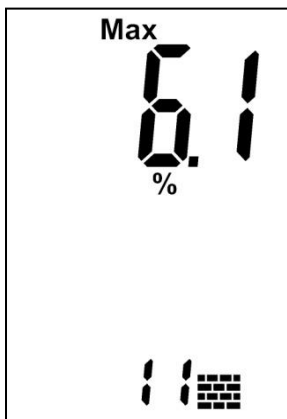

The largest measured value of a series is displayed with the display icon "Max".

Material icon and ID

Figure 2-5 Maximum value menu

To delete a maximum value, the displayed value must be selected by *briefly* pressing the "M" key (measure key).

The value flashes and can now be deleted by pressing the "M" key *longer*.

After that, only the "Max" symbol flashes. Another *brief* press on the "M" key confirms the input and returns the instrument to standby mode.

A new measurement can then be carried out using the "M" key.

Illustrated quick-start guide

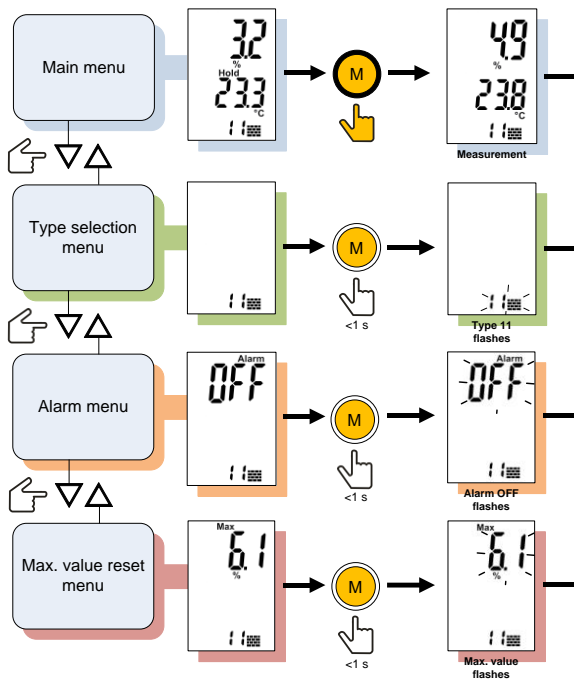

Key



On/Off key: Instrument deactivates after 30 sec. of inactivity



Press the measuring key for any length of time



Hold the measuring key down for more than 2 seconds



Press the measuring key briefly

Illustrated quick-start guide



Mess- u. Regeltechnik GmbH

Software Version:

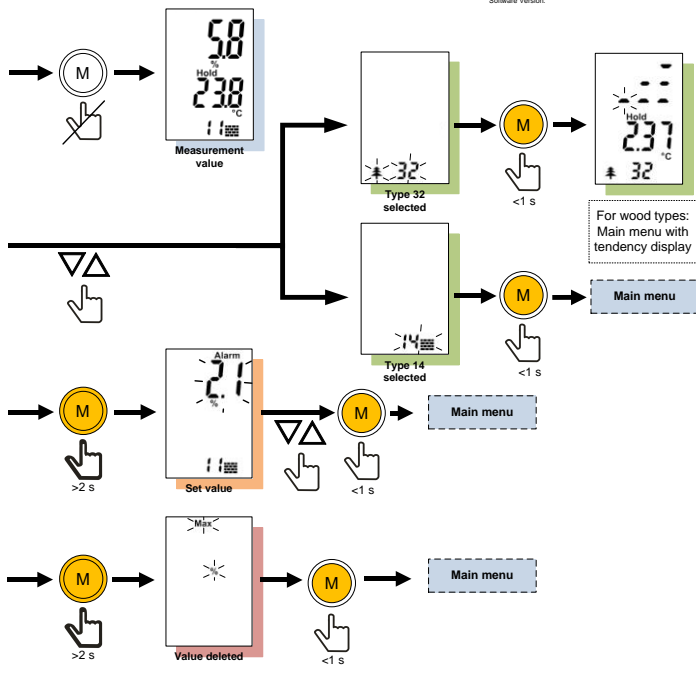

Key



Release the measuring key



Up or down for menu selection



Press the up or down key

2.4 Measurement Menu with Tendency Indicator (only for measuring wood)

If a type of hardwood or softwood is selected in the type menu, a moisture tendency indicator appears in measurement mode. This is depicted as a stairway of horizontal bars.

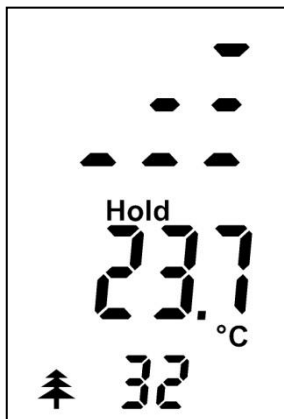

Tendency indicator shown as 6 horizontal bars.

Depending on the moisture value detected, the first bar (“dry”), the middle 2 bars (“equilibrium moisture”) or the last 3 bars (“moist”) will flash.

Material icon and ID

Figure 2-6 Tendency indicator

2.5 Additional Functions

2.5.1 Automatic Shut-down

If no key is pressed for approx. 30 seconds, the instrument switches off automatically. The current data are retained and are displayed again after switching on.

2.5.2 Battery Monitoring

If the battery icon  appears in the display, the battery is empty and must be replaced.

A list of suitable battery types can be found in the "Specifications" section.

3 Specifications

3.1 Technical Specifications

Display:	3-line display
Display resolution:	0.1%
Reaction time:	< 2 s
Storage conditions:	+ 5° to + 40° C - 10° to + 60° C (short-term)
Operating conditions:	0° to + 50° C - 10° to + 60° C (short-term)
Power supply:	9 V battery
Usable types:	Type 6LR61 or Type 6F22
Dimensions:	190 x 50 x 30 (L x W x H) mm
Weight:	approx. 180 g

3.2 Intolerable Ambient Conditions

- Condensation, continuously high air humidity (> 85%) and wet
- Continuous dust exposure and flammable gases, vapours or solvents
- Continuously high ambient temperatures (> + 40° C)
- Continuously low ambient temperatures (< + 5° C)

3.3 Measuring Range

0 to 100 digits (see table for conversion values)

Building moisture: 0.4% to 6.0% wt. (depending on material)

Tendency indicator for hardwood or softwood

Building materials: Cement screed, anhydrite screed, concrete, cement mortar, lime mortar, mixed plaster, gypsum plaster

Insulating materials:

Styrofoam, wood fibre insulation panels

4 Notes on Use

4.1 General Notes

The Hydromette BL Compact B is a dielectric moisture meter for determining the moisture and moisture distribution in building materials, such as masonry, concrete, screed, wood, insulation, etc.

Measurement is based on the measurement principle of the capacitive electrical field. The measurement field forms between the active ball at the upper part of the instrument and the substrate mass to be measured. The change in the electrical field by the material and moisture is registered and digitally displayed (as digits or weight percentage).

The measurement is a relative one, which means that the difference between the dry and moist building material is shown.

An inference as to the absolute moisture by percentage of weight or by moisture per CM percentage is possible only during the normal course of drying.

One influencing factor to be considered is the raw density of the building material to be tested. In general, for dry and moist building materials, as the raw density increases, the displayed value rises correspondingly (see also Chapter 4.4, page 25).

4.2 Orientation Values

The following data serve as a an orientation guide for anticipated display values:

Residential spaces

dry	20 - 40 digits
moist	45 - 70 digits
wet	75 - 100 digits

Cellars (old buildings)

dry	40 - 60 digits
moist	65 - 80 digits
wet	85 - 100 digits

Depending on raw density, readings over 90 digits indicate that condensation is beginning.

Depending on the height of the covering, metal in the subsurface (iron reinforcements, wires, pipes, stucco bars, etc.) can raise the measurement value. This should be considered when evaluating the displayed values in relation to the covering.

4.3 Handling the Hydromette BL Compact B

To prevent any influence from the hand of the operator who is performing the measurement, during the measurement and inspection process, only the rear half can be covered by the hand. The front half (display/ball) of the instrument must remain free.

Handling the instrument properly:

While measuring, always grip the instrument by the lower end of its housing.

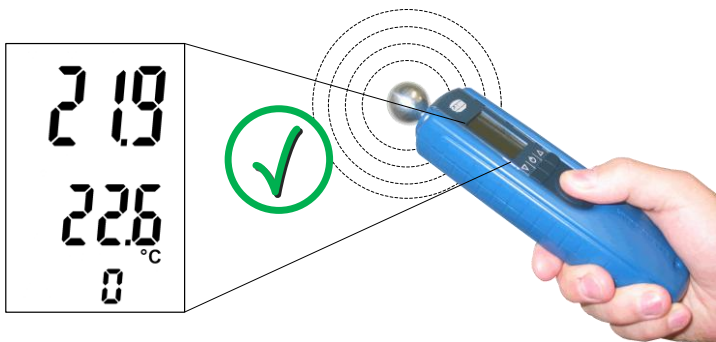

Figure 4-1 Correct handling

Improper handling of the instrument:

During measurement, the hand influences the measurement field of the ball electrode and thereby changes the measurement value, as shown on page 24.

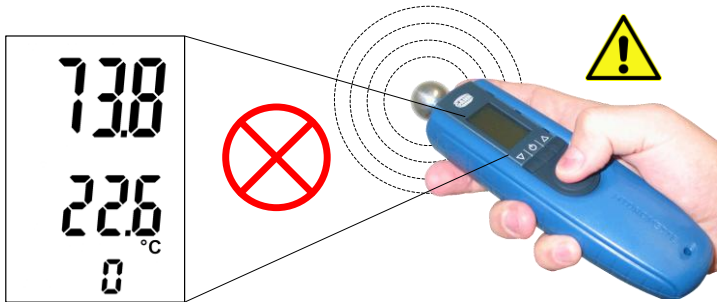

Figure 4-2 Improper handling

Measuring

Press the measurement key “M”, and scan the area to be inspected. The electrode must rest firmly on the building material and be held as vertically as possible (about 90°) to the area. In corner areas, a margin of about 8-10 cm from the edge or angle should be maintained.

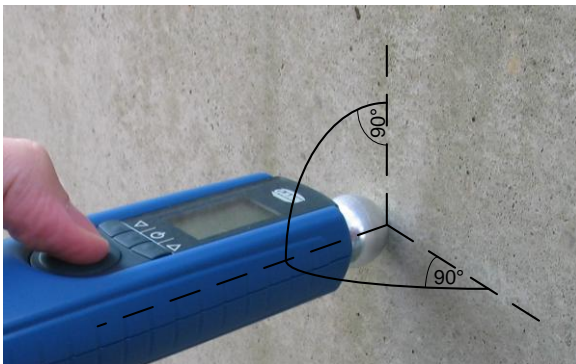

Figure 4-3 Measuring as vertically as possible to the measurement area

4.4 Reading / Conversion Values (digits) in Relation to the Raw Density of the Material

raw density kg/m ³	Corresponding relative humidity 30-----50-----70-----80-----90-----95----100					
	Reading in digits					
	very dry	normal dry	half dry	moist	very moist	wet
to 600	5 - 12	12 - 25	25 - 40	40 - 55	55 - 70	> 70
600 to 1200	12 - 20	20 - 30	30 - 45	45 - 60	60 - 75	> 75
1200 to 1800	12 - 25	25 - 40	40 - 50	50 - 70	70 - 80	> 80
over 1800	20 - 30	30 - 45	45 - 55	55 - 75	75 - 90	> 90

The weight percentages and CM percentages calculated and directly displayed by the instrument are benchmarks. They relate to a normal drying process with natural reductions in moisture between the accessible depth, depending on the raw density. If the building material dries too quickly (due to warm air, dehumidifiers, floor heating, etc.) too low a measurement value may be displayed because of the low moisture of the surface.

The depth effect is largely dependent on the respective raw density and surface moisture. Normal plaster and screed thicknesses are used when programming the values into the instrument.

Caution:

The notes and charts on allowable or common moisture conditions in practice and general definitions given in these instructions were taken from the technical literature. The instrument's manufacturer can therefore not guarantee their accuracy. The conclusions drawn from the measurement results depend on each user's individual requirements and practical, professional empiricism.

5 Annex

5.1 Materials Table

0	Reading in digits	
11	Cement screed in wt.%	
12	Anhydrite screed in wt.% / CM%	
13	Concrete in wt.%	
14	Cement mortar in wt.%	
15	Lime mortar in wt.% / CM%	
16	Mixed plaster in wt.%	
17	Gypsum plaster in wt.% / CM%	
18	Cement screed in CM%	
21	Styrofoam in wt.%	
22	Fibre board insulation in wt.%	
32	Hardwood	(tendency indicator)
33	Softwood	(tendency indicator)

5.2 Comparison Graph of Humidity - Material Moisture Content

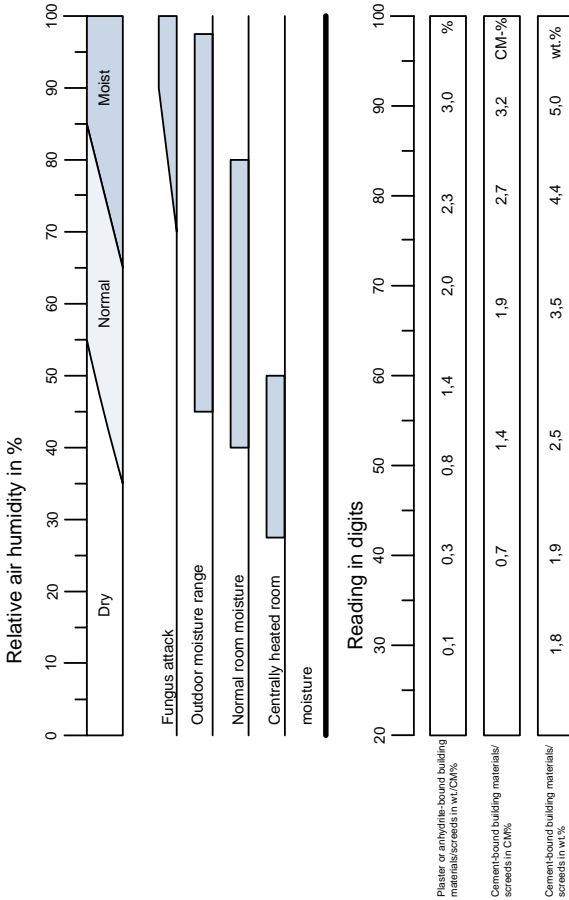

Notes on graph in Section 5.2:

The zones shown in the graph indicate:

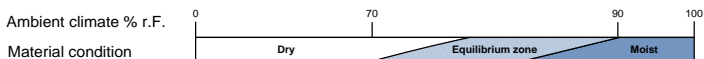

Pale zone: Dry

Equilibrium moisture.

Hatched zone: Equilibrium zone

Caution! Non-diffusing coverings or adhesives should not be used.
Please ask the respective manufacturer.

Dark zone: Moist

Machining or processing at very high risk!