

EE671

HVAC Miniature Air Flow Transmitter

EE671 is a compact air velocity probe for HVAC applications. The built-in flow sensing element VTQ combines the advantages of state-of-the-art E+E thin-film manufacturing and of the newest transfer molding technology.

It operates on the hot-film anemometer principle and ensures high accuracy and reproducibility as well as long-term stability and outstanding resistance to pollutants.

EE671 is available with fix installed cable or with plug connection. The measured air velocity up to 20 m/s (4000 ft/min) is available as linear voltage output 0 - 1 V, 0 - 5 V or 0 - 10 V. The alignment strip on the probe and the matching mounting flange within the scope of supply simplify installation and correct positioning in the air flow. The flange enables the immersion depth to be infinitely variable.

With an optional configuration kit the user can set via a digital setup interface the output configuration and perform an adjustment of the probe.

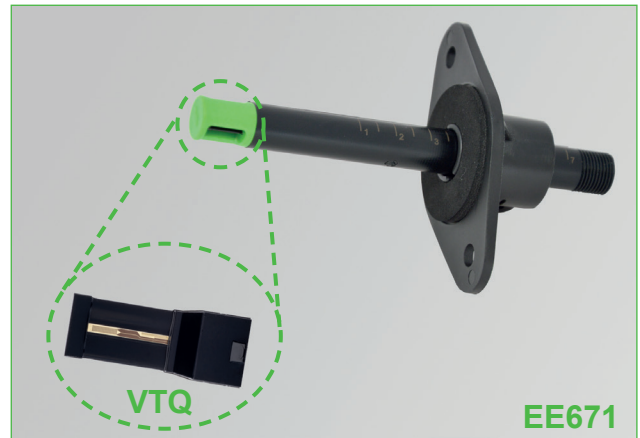

Typical Applications

Heating and ventilation systems
 Flow monitoring and control
 Inlet air monitoring in ovens

Features

High accuracy and long-term stability
 Outstanding resistance to contamination
 Easy and quick mounting
 User configurable

Technical Data

Flow measurement

Measurement range ¹⁾	0...5 m/s (0...1000 ft/min) 0...10 m/s (0...2000 ft/min) 0...15 m/s (0...3000 ft/min) 0...20 m/s (0...4000 ft/min)
Output signal ¹⁾	0 - 1 V (max. 1 mA) 0 - 5 V (max. 1 mA) 0 - 10 V ²⁾ (max. 1 mA)
Accuracy ³⁾ at 20 °C (68 °F) / 45 % rh and 1013 hPa (14.7 psi)	0.5...5 m/s (100...1000 ft/min): ±(0.2 m/s / 40 ft/min + 3 % of measured value) 1... 10 m/s (200...2000 ft/min): ±(0.3 m/s / 60 ft/min + 4 % of measured value) 1... 15 m/s (200...3000 ft/min): ±(0.35 m/s / 70 ft/min + 5 % of measured value) 1... 20 m/s (200...4000 ft/min): ±(0.4 m/s / 80 ft/min + 6 % of measured value)
Response time τ_{90}	typ. 4 s

General

Supply voltage	10...29 V DC SELV
Current demand	max. 50 mA at 20 m/s (4000 ft/min)
Temperature range	operation: -20...60 °C (-4...140 °F) storage: -30...60 °C (-22...140 °F)
Operating range humidity	5...95 % rh (non-condensing)
Connection	
Cable version	0.5 m (1.6 ft) / 2 m (6.6 ft) cable, PVC, temperature-flexible, 5x0.25 mm ² (AWG 23) with ferrules
Plug version	M12 connector system, 5-pin
Electromagnetic compatibility ⁴⁾	EN61326-1 EN61326-2-3
Material / protection class	polycarbonate / IP50 (probe head); IP54 (housing)



1) See ordering information

2) Only at supply voltage $V_+ \geq 15$ V

3) The accuracy statement includes the uncertainty of the factory calibration with an enhancement factor $k=2$ (2-fold standard deviation). The tolerance was calculated in accordance with EA-4/02 following the GUM (Guide to the Expression of Uncertainty in Measurement).

4) The EE671 is not short-circuit-proof and not surge-proof (ESD-sensitive device).

Dimensions (mm/inch)

Cable version

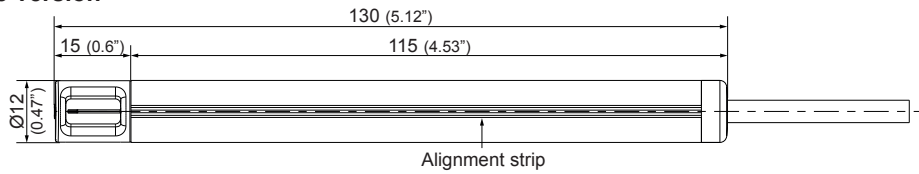

Front view Measurement head:

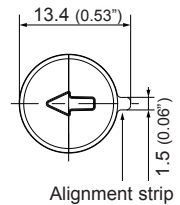

Plug version

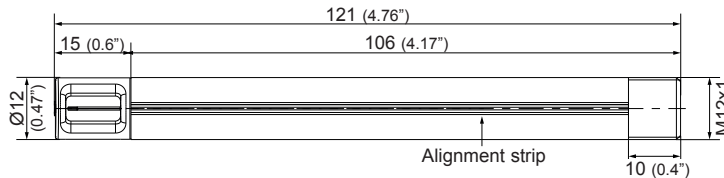

Flange (within the scope of supply):

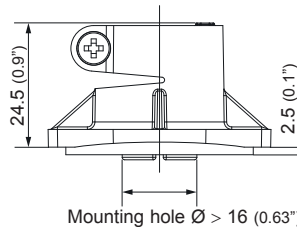
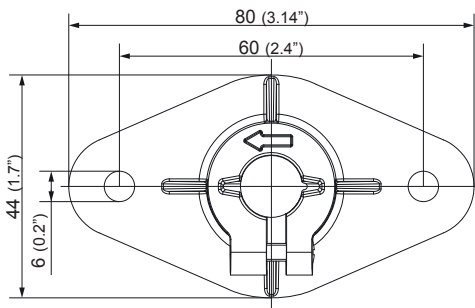

Cable Assignment

V+white
GND.....brown
Analogue output...green
SDA*).....grey
SCL*).....yellow

*) digital setup interface E2

PIN-Assignment Plug

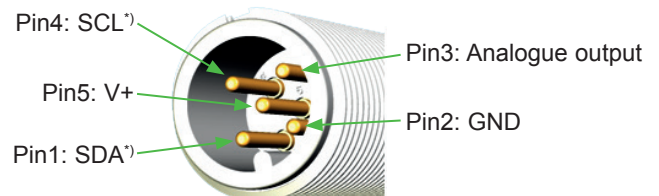

Ordering Information

MODEL	ANALOGUE OUTPUT	DIGITAL OUTPUT	MEASUREMENT RANGE	DESIGN	CABLE LENGTH
air velocity	0 - 1 V (1)	none (x)	0...5 m/s (0...1000 ft/min) (C)	cable version (K)	0.5 m (19.7") (A)
	0 - 5 V (2)		0...10 m/s (0...2000 ft/min) (D)	plug version (S)	2 m (79") (D)
	0 - 10 V (3)		0...15 m/s (0...3000 ft/min) (E)		plug version (x)
			0...20 m/s (0...4000 ft/min) (F)		
EE671-					

Order Example

EE671-V2xDKA

Model: air velocity
Analogue output: 0 - 5 V
Digital output: none
Measurement range: 0...10 m/s (0...2000 ft/min)
Design: cable version
Cable length: 0.5 m

Accessories (see data sheet „Accessories“)

Product configuration adapter see data sheet EE-PCA
Product configuration software EE-PCS
(free download: www.epluse.com/EE671)
Mounting flange HA010214

Especially for plug version (Design S):

Field attachable connector (with screw terminals) HA010708
Connecting cable, 5-pin, 2 m (79"), M12 plug HA010816
Connecting cable, 5-pin, 5 m (197"), M12 plug HA010817
Connecting cable, 5-pin, 1.5 m (59"), open ends HA010819
Connecting cable, 5-pin, 5 m (197"), open ends HA010820